

wolcraft®



Guide to Wood Joints

Contents	Seite
Wood joints	
Introduction to dowelling	3
The round dowel	4
The dowelling toolkit	5
The basics	6
The Dowelmaster	
Corner joints	7
T joints	8
Face joints	8
The Universal Dowelling Jig	
Corner joints	9
T joints	10
Face joints	10
The Dowelling Jig	
Face holes	11
Corner joints	12
T joints	12
Face joints	13
Series of holes	13
Biscuits	14
The multi-purpose wood jointer	
Corner joints	15
T joints	16
Face joints	17
Mitre joints	17
The concealed screw joint	18
The Undercover Jig	19
Corner, T and face joints	20
Frame and mitre joints	21
Repair assistant	22
Conical plates	23
All products at a glance	24

wolcraft® Guide to Wood Joints

Anyone who has ever joined boards of wood with round dowels and no further assistance certainly knows that moment of suspense when the boards are put together and the crucial question arises: does it fit or doesn't it?

The probability of a perfect fit without the use of suitable dowelling aids is about as good as the chances of winning the jackpot in the lottery. For this reason, we at wolcraft® have occupied ourselves for decades with the development and production of dowelling aids which make it possible to create perfect, precisely fitting dowel joints. However, these products are intended not only to function precisely but at the same time to be simple to use.

We have written this Guide for you, to give you an idea of just how easy our dowelling aids are to use. Over 25 pages, showing you step by step everything you need to know on the subject of wood joints. Numerous photographs and many tips and tricks for the different dowelling devices make this Guide the ideal reference work. It should find a permanent place in your home workshop so that you are ideally equipped for all your home handicraft projects, and so that in future you will be able to make wood joints like a professional.

We wish all interested home craftsmen and readers of this Guide great pleasure and success in making wood joints with wolcraft® products.

wolcraft® GmbH

Exclusion of liability:

The author developed the methods and techniques described and the proposals and recommendations made with care, and tested them himself. Nevertheless no warranty can be made. Liability of the author and of the company wolcraft® for any personal injury or damage to property or assets is excluded.

We reserve the right for minor modifications concerning appearance, colours, dimensions and weights as well as technical details.

Paper made from non-chloride bleached materials.

© 2014 by wolcraft® GmbH
Wolff-Straße, 56746 Kempenich
Service Hotline: 00 49 (0) 26 55 51 280

All rights reserved. This work is protected by copyright. Any usage beyond the cases regulated by law requires permission from the author, in writing.

Joining wood together



Anyone who wants to make storage shelves for the cellar quickly and easily, usually reaches for the portable electric drill and the appropriate chipboard screws. But what is fine for the cellar, is really unthinkable in the living area. Who wants to find themselves looking at screw-heads in the sides of the shelves? Certainly you can fill in these holes with putty or mortar – but that doesn't look so great either! For such cases you need wood joints that are as far as possible invisible, or decorative, and that is what we would like to tell you about on the following pages.

Decorative and invisible wood joints



Round dowel joint

The best-known “invisible” wood joint is a dowel joint made with round dowels. These are particularly popular because all that is needed to make them, is a power drill and the right wood drill bit. Both of these can be found in almost every household, and so it is not surprising that almost every home craftsman has acquired some degree of good experience with round dowels.



Biscuit joints

Less well known are wood joints made with biscuits. However, these have a very significant advantage over round dowel joints. The oval shape of the biscuit plates makes it possible for the joint still to be shifted in one dimension, in contrast to the round dowel. A guidance, on how quickly and easily these biscuits can be cut, is starting on page 14.

The dowel joint

Field of use of the round dowel

The round dowel

Wooden boards are most often joined with round dowels. Round dowels are normally produced from beechwood and are available in various diameters and lengths. They are inserted into a predrilled hole and obtain their stability in wood from the addition of wood glue. Therefore, the surface has small longitudinal grooves, also known as fluting, in order to achieve the maximum stability. When the glue is applied to the hole and the dowel then inserted, the glue is pressed along the dowel in the longitudinal grooves.

Wooden dowels are also known as fluted dowels because of these grooves, and must not be confused with ordinary round rods.

Round rods are completely unsuitable as dowel substitutes because they do not have these grooves. This results in most of the glue remaining deep in the drilled hole when the rod is inserted, instead of being pressed out along

the rod. Every carpenter and cabinetmaker works with these round dowels when he wants to join wooden parts quickly, without complication and extremely firmly. The home craftsman can also easily use this extremely effective method. Wooden dowels can be drilled into wood either visibly or invisibly.



While even an unpractised home craftsman achieves good results right from the start drilling wooden dowels that are visible, the invisible joining of wood parts with round dowels is significantly more difficult. Here, the two wood parts must be drilled on the inside, and the two drill holes must be positioned precisely opposite each other. Since the necessary precision of drilling is rarely achieved just by marking the centre drilling point with pencil and rule, dowl-ling aids or dowel templates are used to help in positioning the dowels.

Field of use of the round dowel



Corner and T joints:

In furniture construction, almost any cabinet can be made with these two types of joint. The round dowel is thus exceptionally well suited to the construction of furniture. Whether chairs, tables, or even cabinets, round dowels are found everywhere as the joining element, and every one of these joints can be classified either as an L-shaped corner joint (upper circle) or a T joint (lower circle).



Face joints:

With round dowels, boards can even be lengthened in area, or joined at the corner to form a frame. Reinforcement of the mitring of a picture frame is also an excellent field of use for round-dowels.

Dowelling aids and accessories



The Dowelmaster is the rapid dowelling tool for almost every work situation. Whether corner, t- or face joint, the precision of the joint is outstanding, and the handling is very simple.



The Dowelling Jig is a real multitalent, and can be used not only for dowelling but also for drilling rows of holes. In addition, this aluminium profile is excellently suited for use as a drawing rule or guide for the jig saw.



The Universal Dowelling Jig achieves particularly high precision in dowel jointing because with its attachment elements it is made fast both to the work bench and to the workpiece.



Dowelling Accessories: round dowels in the standard diameters 6, 8, and 10 mm, the appropriate wood drilling bit with a depth stop, and the matching dowel markers for the counter-holes are the most important accessories for dowelling.

Power tools for dowelling



Dowelling does not require an expensive collection of equipment. All you need in addition to the dowelling tools shown above is a power drill or a portable electric drill for drilling the dowel holes. A portable electric drill has the advantage that there is no cable hanging in the way, and that it is usually somewhat lighter than a power drill. However, with a portable electric drill, you should above all take care to drill in 2nd gear (fastest speed) and to switch off the torque regulation or to set it to the drilling symbol.

Important measurements in dowelling



For corner and T-joints, the holes must be drilled no more than 2/3 of the thickness of the wood, at the most. The remainder of the dowel, plus 2 – 3 mm space for glue, will be inserted into the opposite side or into the face of the board. Therefore, you should take care to always for example: with wood 18 mm thick and a dowel length of 40 mm, drill 12 mm into the surface and 28 mm plus 2 mm space for glue, making a total of 30 mm, into the face.



For face joints, half the length of the dowel plus c. 2 mm space for glue should be drilled into each of the boards.

Wood thickness	Dowel Ø
12 – 14 mm	6 mm
15 – 18 mm	8 mm
19 – 30 mm	10 mm

The dowel diameter should be between 2/5 and 3/5 of the thickness of the wood. The table above shows the appropriate dowel diameters for the most common wood thicknesses.

The right way to drill dowel joints



1. Always insert the drill bit into the drill bushing before switching on the drill.
2. Always move the drill perpendicularly without any lateral pressure in the drill bushing.
3. Always move the drill backwards and forwards to improve the removal of sawdust during drilling.

Dowel markers



Dowel markers (also known as dowel tips) are of great assistance in precisely locating the centres of the counter-holes. They are simply inserted into the dowel holes already drilled. The complete assembly is then laid on the board to be marked, and the tips of the markers mark out the exact drilling points for the counter-holes.

The right way to glue dowel joints



Always put the glue into the face holes first, and make sure that the dowel does not stand out more than 2/3 of the thickness of the wood.



Apply glue not only into the dowel holes, but also onto the faces of the shelves, to further increase the firmness of the glue joints.

The Dowelmaster

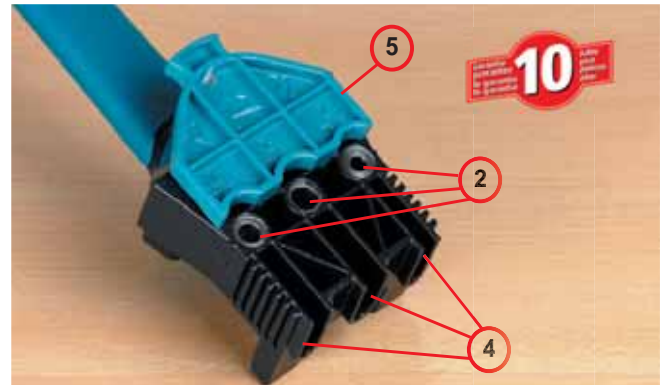
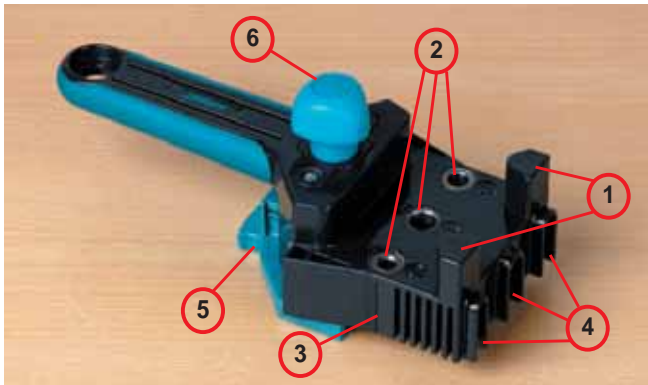

Wood thicknesses up to 30 mm can be joined using this dowelling aid. The board is clamped between the centring pins (1) while dowelling the face holes, ensuring that the dowel holes are always precisely in the centre of the edge. The drill is inserted into three steel bushings (2) for 6, 8 and 10 mm dowels.

The centre of the dowel is additionally shown by a mark (3) on the side of the dowelling jig. Three guide grooves (4) are provided on the device itself for transferring to the corresponding counter-holes. An adjustable fence (5) is fixed in place with a fastening screw (6).

Drilling face holes with the Dowelmaster

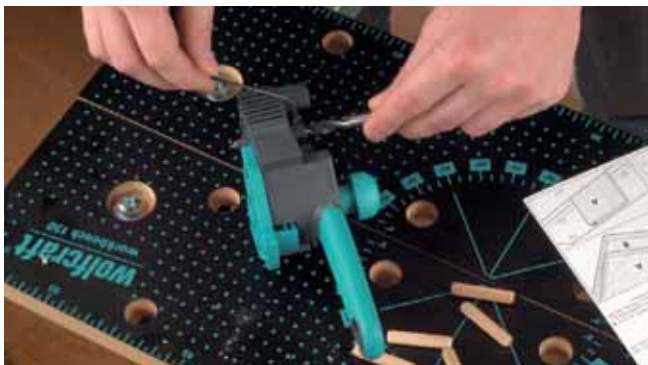

Then set the depth stop of the drill according to the thickness of the board and the dowel length being used.

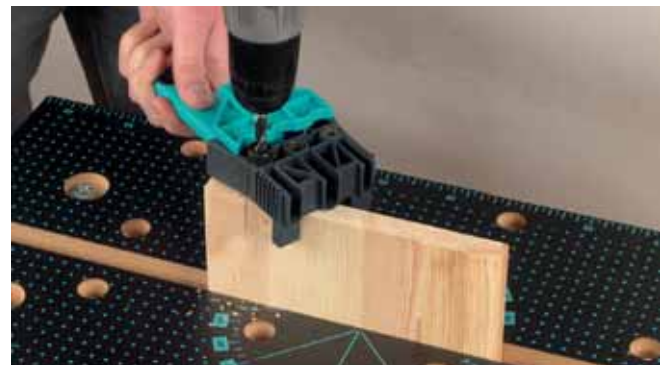

Position the Dowelmaster on the board and clamp the board between the two centring pins.

Making corner joints with the Dowelmaster



To make a corner joint, you first need to drill all the face holes (see above).



In order to be able to drill the counter-holes, the dowels must first be glued into the face holes.

The Dowelmaster

T and face joints



To adjust the fence of the Dowelmaster to the dowels already drilled, loosen the fastening screw and insert the dowels into the corresponding drill bush of the Dowelmaster.



Then slide the fence firmly up against the side of the board and secure it with the fastening screw. Now the fence is precisely adjusted to the centre of the dowel and of the board.



Clamp the face board board with the dowels on to the board that is to be drilled and slide the Dowelmaster with the guide groove over the dowel. The fence then butts firmly against the lower edge of the board.

T joints with the Dowelmaster



When T joints (e.g. for centre shelves) are to be made, the Dowelmaster is used without the angle fence.



Mark the centre of the shelf on the side board and clamp the shelf at a distance of 40 mm.



Then slide the Dowelmaster with the guide groove over the dowel, and drill. After this, apply glue to the boards.

Making face joints with the Dowelmaster

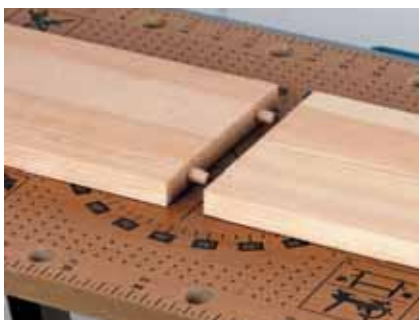

Face joints can also be made rapidly and extremely precisely with the Dowelmaster.



Position the Dowelmaster on a dowel, slide the angle fence against the side of the board, and tighten the screw.



Clamp the two boards into the workbench. Slide the Dowelmaster with the guide groove over the dowel, and drill.

The Universal Dowelling Jig

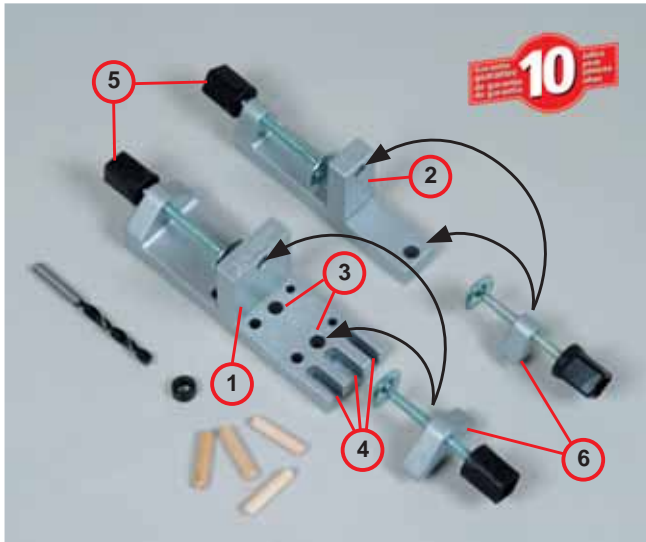

The Universal Dowelling Jig consists of a drill guide (1) and a board clamp (2). The drill guide has two rows of drill bushes (3) for 6, 8 and 10 mm dowels. There is a guide groove matching each dowel size (4) in front of the bushes for holding the drilled in dowels. The board clamp does not have drill bushes, and serves only to support or clamp the boards. Drill guide, board clamp and board are clamped together with clamping screws (5). Two adjustable clamp supports (6) are used to clamp the other board. In addition, they can be inserted into two drill holes (black arrow) and thus clamp the boards either horizontally or vertically.

Making corner joints with the Universal Dowelling Jig



Mark all shelf bottoms with a cross on the edge and the side walls with a cross on the wood surface.



Screw the shelf bottom tight to the workbench with the Universal Dowelling Jig and insert the two clamp supports.



Insert the side wall into the dowelling jig, match the wood edges precisely to each other with an angle, and clamp them tight.



Then drill both the face hole into the shelf bottom and the hole into the side wall.

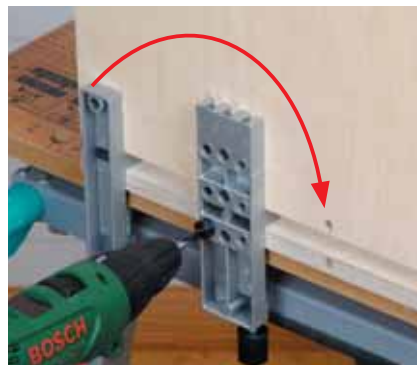

Slide the Universal Dowelling Jig along so that the next dowel can be drilled. To finish, ...



... first switch the board clamp from the left corner to the right. Only then, slide the drill guide to the last hole to be bored.

Making T joints with the Universal Dowelling Jig

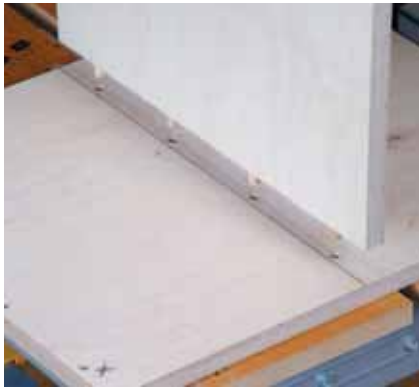

To make T joints, the first step is to drill face holes into the shelf bottom.



Mark out the intervals of the dowels and fasten the shelf bottom to the workbench with the Universal Dowelling Jig.



To drill the last dowel hole, the board clamp is again shifted from left to right.



In order to be able to transfer the holes to the counter-board, the dowels must first be glued in.

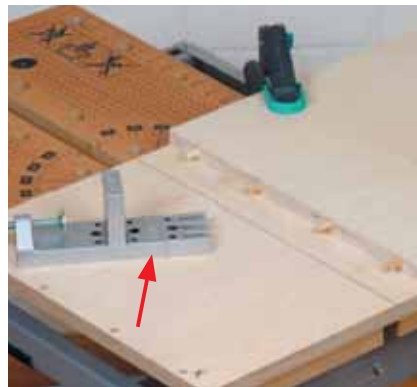

Draw the position of the shelf bottom on the side wall and fasten it with clamps.



The distance between the shelf bottom and the pencil line is given by a notch on the side of the Universal Dowelling Jig...



... Slide the Universal Dowelling Jig over the dowel with the appropriate guide groove and drill. The boards can then be glued.



With the Universal Dowelling Jig, you can also join the faces or longitudinal edges of two boards together rapidly and precisely.



The two boards are clamped into the Universal Dowelling Jig at the same time. This guarantees that the counter-holes fit absolutely perfectly.

The Dowelling Jig

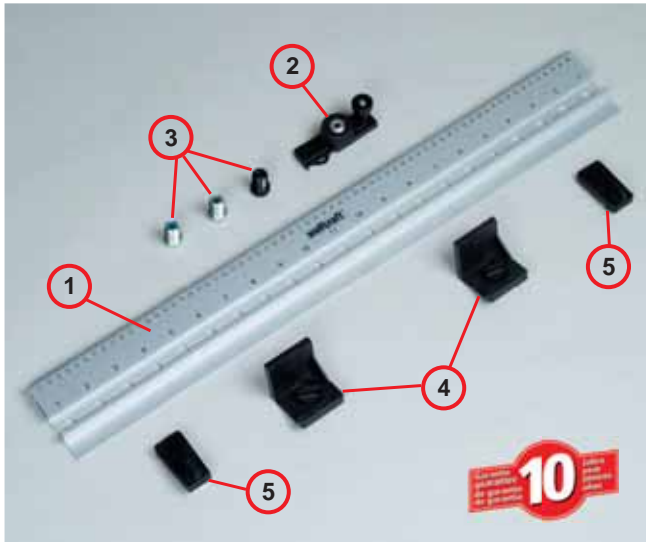

The Dowelling Jig consists of a guide rail (1) with catch holes at intervals of 32 mm. A sliding drill head can be engaged in these holes, which is equipped with a 5, 6, 8 or 10 mm drill bush (3). This makes possible rows of dowels and holes at intervals of 32 mm. The distance of the holes from the edge of the board is determined with the angle fences (4) which are inserted under the profile. Distances from 12 - 40 mm can be selected (in 4 mm steps). The side stops (5), which are also inserted under the profile and engage in the holes of the Dowelling Jig from below, are set at the start and end of the row of dowels.

Drilling face holes with the Dowelling Jig



First the sides and floors are marked so that they can be recognised during drilling.



Then measure the thickness of the wood of the plates in order to set the stops of the Dowelling Jig to this measurement.



Set the angle fence to the value that is nearest to the thickness of the wood. (e.g. for wood thickness 19 mm, set to 20)



Align the Dowelling Jig centrally under the board and secure the side stops to the board left and right...

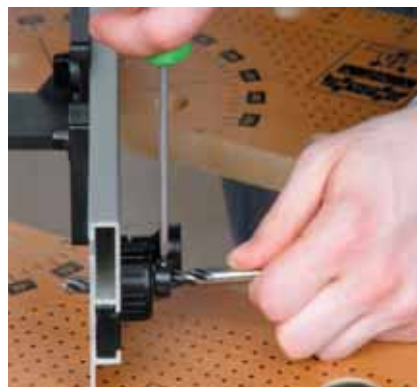

...in the same and next possible drill holes. Then adjust the drill bit to the thickness of the wood and the length of the dowel, using the depth stop.



Slide the Dowelling Jig with the left stop against the left edge of the board and fix it with screw clamps.

Making corner joints with the Dowelling Jig



Lay the Dowelling Jig on the side wall and slide the left side stop against the left board edge.



Then fasten the Dowelling Jig to the board with screw clamps. Take care that the sliding drill head ...



... engages in the same holes of the Dowelling Jig as for the drilling of the face holes. The holes are numbered for this purpose.

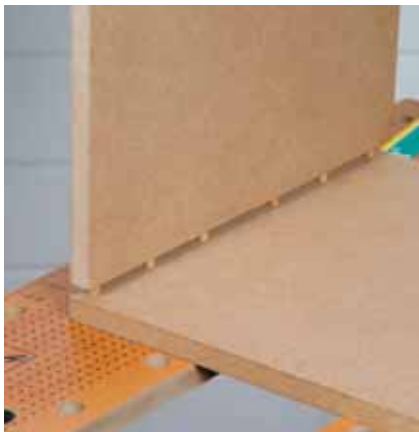

The Dowelling Jig is distinguished by great precision and simple handling, which make exact dowelling just really easy even for the inexperienced.



You no longer need any large collection of machines or accessories for constructing your own furniture. Power drill and Dowelling Jig are quite sufficient!

Making T joints with the Dowelling Jig



Since the angle fence was set to 20, a centre line at a distance of 10 mm must be drawn from the bottom.



Remove the angle fences and align the Dowelling Jig to the centre line, and fix the whole assembly with clamps.



Again take care that the sliding drill head is engaged in the same holes of the Dowelling Jig as it was for drilling the face holes.



When assembling, pay attention to the correct position of the separate components, since the dowels are not located precisely in the centre of the edge.

Drilling a series of holes

The Dowelling Jig

Making face joints with the Dowelling Jig

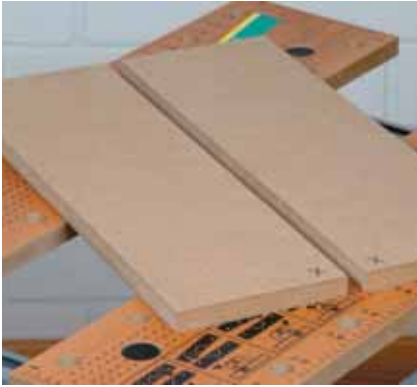

The Dowelling Jig is particularly well suited for making face joints with a high number of dowel holes.



A dowel can be drilled in every 32 mm, making the joint extremely stable.



The two boards are drilled one after the other with the same setting, and thus fit together perfectly.

Drilling a series of holes at pitch 32 with the Dowelling Jig



A series of holes at pitch 32 serves to secure concealed hinges, drawers and shelf supports.



Replace the present drill bush with the 5 mm bush to drill the row of holes.



Position the Dowelling Jig with the levelled off edge flush with the edge of the wood and fix it with screw clamps.



To drill additional holes at intervals of 32 mm, simply insert a 5 mm drill bit into the last drill hole.

The Dowelling Jig as a drawing rule



The Dowelling Jig is manufactured from a high quality aluminium section which is also ideal as a stop bar for ...



... a jig saw, a pencil or a cutter. The scale on the edge is particularly helpful.

Biscuits

One of the best inventions in wood-working in the last 60 years is and remains the biscuit jointer. This machine was invented in 1955 by the Swiss master cabinetmaker Hermann Steiner. Biscuits are oval or elliptical 4 mm thick diagonal grain wooden plates which are inserted into a slot which has previously been routed out. In contrast to round dowels, their elliptical shape allows them to be adjusted or aligned in the 4 mm wide slot. This makes it easier to position the wood parts precisely for gluing. Above all, the gluing surface of a biscuit is substanti-



ally greater than that of a round dowel. This, together with the swelling of the biscuit when glue is applied, leads to the extreme load bearing capacity and stability of a biscuit joint. All you need to create a biscuit slot is the Multi-purpose Wood Jointer and an ordinary commercial angle grinder to drive the 4 mm thick saw blade. When selecting the angle grinder, you only have to make sure that it has a grip on both sides so that the Multi-purpose Wood Jointer can also be attached on each side of the motor. Otherwise almost any angle grinder will work with the Multi-purpose Wood Jointer.

Fields of use of the biscuit



Due to its rapid and extremely precise application, the biscuit is the ideal joining method for constructing furniture. It even makes it possible to construct both complex installations in loft spaces (left, above) and simple ...

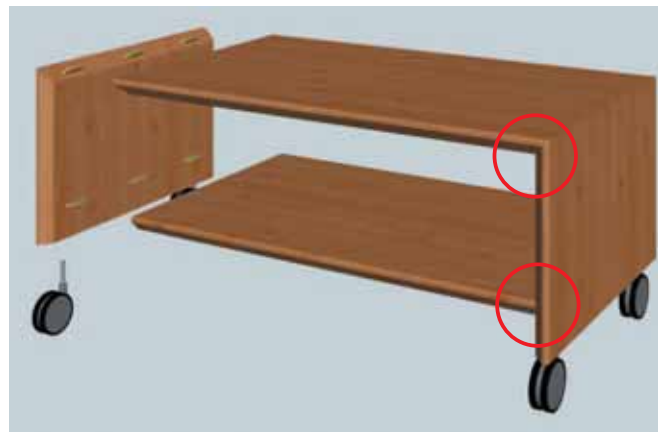

... corner joints for constructing drawers (left, below) rapidly and easily. Biscuits are particularly well suited for mitring joints (right, above) and as joints for kitchen worktops (right, below).



The Multi-purpose Wood Jointer



The Multi-purpose Wood Jointer is an attachment for an angle grinder, which, after the clamping nut and wheel flange are removed, can be fastened directly into the screw opening (1). Then the lateral machine brackets (2) are fastened with the screws provided (3) to the two grips of the angle grinder. The motor of the angle grinder drives a 4 mm thick carbide tipped saw blade (4). This can be moved forward out of the housing (5) using a slider. The extent to which the saw blade can be slid out is controlled with the depth setting (6). An angle bracket (7) for 90 and 45 degrees can be attached to the housing.

The biscuit sizes

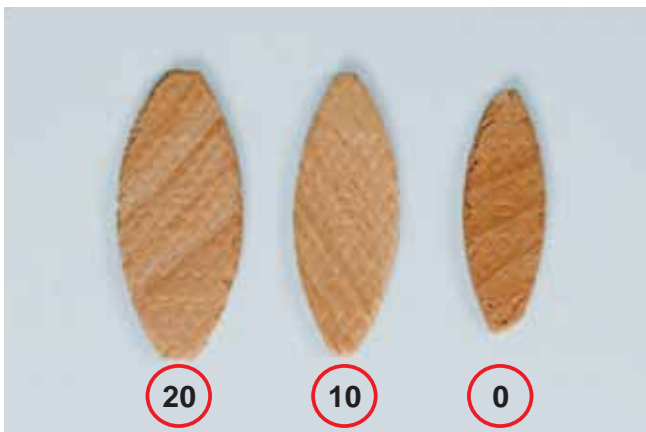

Biscuits come in three sizes: types 0, 10 and 20. The biscuit size to be used depends on the thickness of the wood boards that are to be joined. The rule of thumb is:

- type 0 biscuit = 10 – 12 mm wood thickness
- type 10 biscuit = 13 – 15 mm wood thickness
- type 20 biscuit = from 16 mm wood thickness

These biscuit sizes are preset on the depth setting (6) and can be selected by turning the rapid adjustment to the required size.

Making corner joints with the Multi-purpose Wood Jointer



Identify your boards with a triangle as side walls or as top or bottom boards.



Depending on the board size, it may be necessary to insert a dowel in the centre in addition to the two outer biscuits.



Then clamp a board vertically onto the workbench. The board must be precisely at right angles to the work surface.

The multi-purpose Wood Jointer

T joints



Position the side walls side-on against the clamped board and cut the biscuit slots.



Then lay the top or bottom flat with the outside edge on the workbench, and cut the slot into the face of the board.



Side walls and floors are joined together in a moment by this method, and fit together perfectly first time.

Making T joints with the Multi-purpose Wood Jointer



Align the bottom precisely to the side wall using an angle, and mark the position.



Then turn down the floor, align it to the marking, and clamp it tight. Apply the machine to the edge of the wood ...



... and cut the slot into the side wall. Then lay the machine flat and cut the face edge.

Tips and tricks with the Multi-purpose Wood Jointer



If the bottom shelf is to be positioned higher, e.g. for a baseboard, the machine is supported with a board of the appropriate thickness.



For thinner boards (< 18 mm), in order for the slot to be located roughly in the centre of the edge a small plywood board is laid under the edge of the wood ...



... and plywood of the same thickness is laid under the board when cutting the counter-slot, e.g. underlay 12 mm wood thickness with 4 mm plywood.

Making face joints with the Multi-purpose Wood Jointer



To join a kitchen work surface with biscuits, first mount the angle bracket supplied.



Then lay the angle bracket on the visible side of the work surface and 4 or 5 biscuits are cut into the edge ...



... This makes the junction of the two boards on the upper side always absolutely flat and even.

Making mitre joints with the Multi-purpose Wood Jointer



When all picture frame strips have been mitred, mark the centre of the mitring.



Then clamp the strip and align the centre of action of the machine to the pencil marking.



Select the biscuit size according to the mitring. Particularly narrow strips are better joined with round dowels.



If cabinets like this dressing table are to be joined with mitring, the Multi-purpose Wood Jointer is the perfect tool.



For exact 45-degree mitring, use the angle frame, simply mounting it on the front of the housing.



When applying glue to mitring, use fastening straps to distribute the pressure better.

The concealed screw joint

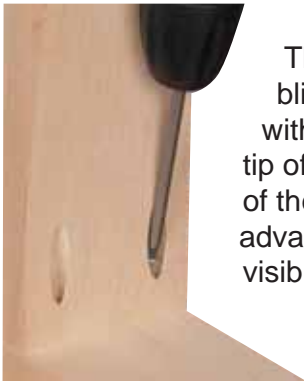

The principle of this rapid, exact and highly durable joint is a diagonally drilled blind hole (pocket hole). In order to be able to make this hole precisely and without the drill going astray, a drill guide is used with a stepped drill design. The tip of the drill makes a small guide hole for the screw thread, while the second step of the drill makes a larger hole for sinking the screw head in the wood. The great advantage over a normal screw assembly is that in this way, the screws are not visible from outside.

Fields of use for the concealed screw assembly



Joining

Concealed screw assemblies are not only excellent suited for the construction of cabinets and shelves, but also provide precise and durable joints in making frames.



Reinforcing

A drawer that “wobbles” at the corners can be reattached in just a few minutes, with just two little tricks. It doesn’t even have to be taken apart to do it.



Repair

Only two work steps are needed to join a broken cabinet corner firmly back together. The cabinet does not even have to be taken apart for this repair, which takes only five minutes.

The advantages at a glance!

- quick and easy to use
- no expensive tools or accessories needed
- joint is made with ordinary screws
- precise and extremely durable joint
- joint can take the strain immediately
- joint can be released at any time
- joint can additionally be glued
- no waiting time when using glue
- joint not visible from outside
- holes can be sealed almost invisibly with special dowels or wax putty
- lightening fast repair assistance for corner joints that are coming apart, such as in cabinets or drawers, which do not have to be taken apart for the repair

The Undercover Jig



The Undercover Jig (1) is supplied with everything you need – apart from the power drill and a small screw clamp for clamping the drill guide to the workpiece – to create a concealed screw assembly. The matching step drill bit with depth stop (3) and the extended bit attachment (4) for conveniently screwing the joint are all included. The Undercover Jig can therefore be used immediately by every home craftsman who has a power drill or a portable electric drill. Almost any wood and almost any board material can be joined with the drill guide. We recommend the following screw sizes, depending on the thickness of the wood:

Wood thickness	Screw size
from 12 mm	4 x 25 mm
from 19 mm	4 x 30 mm
from 27 mm	4 x 40 mm
from 38 mm	4 x 60 mm

For repair work (e.g. fixing cupboard shelves firmly to the side walls again, see p. 22), the screws should be 5 mm longer.

The whole sequence in just three steps



1. Measure the thickness of the wood

The Undercover Jig can be preset to various wood thicknesses. The thickness of the wood parts to be joined should therefore first be measured with the scale on the side of the Undercover Jig.



2. Set the thickness of the wood

The scale on the other side of the Undercover Jig shows the different wood thickness of 12, 19, 27 and 38 mm. By pressing the release knob, you can slide the bush – to one of these values and engage it.



3. Set drilling depth

Turn the Undercover Jig over and insert the drill deep into the right drill bush, such that the edge of the second, larger drill step (red arrow) meets the mark for the required wood thickness. The drilling depth is firmly set at this position with the depth stop.

Undercover jig

Corner, t and face joints

Making a corner joint



Place the Undercover Jig on the board so that it butts onto the edge of the board with the stop. Fasten the board and the Undercover Jig to the workbench with a clamp and drill a diagonal pocket hole or blind hole as far as the depth stop with the stepped drill. During this, keep moving the drill slightly backwards and forwards so that the sawdust can be ejected better.



Then fix the wood pieces that are to be joined precisely with a clamp. The more precisely the wood pieces are clamped together, the better the whole corner joint will be in the end. Following this, insert the extended bit attachment into the portable electric drill and screw the screw appropriate to the thickness of the wood into the pocket holes (see table page 19).



Of course it is also possible to screw the board with the drill holes outwards. Thus you always have the option to choose the working method that is most convenient for you depending on the work situation. For a concealed screw joint, in any event, drill only boards that butt with their face onto another board.

T joint



For a T joint, the holes are made in exactly the same way as for a corner joint. Then the drilled board is simply clamped against the counter-board in the required position, and both wood parts are firmly joined with the appropriate screws. If it is not going to be necessary to undo the joint, it can additionally be glued, for greater stability.

Making a face joint



A concealed screw joint is also a rapid and very durable alternative for face joints. For picture frames and radiator paneling, for example, drill holes visible from the rear are in no way disturbing. But even these joints can be sealed almost invisibly with colour matched wax putty or the angled dowels supplied.



What is important is, regardless of what joint is being made, that the workpieces are fixed firmly and precisely in place with clamps, so that they cannot slip when being screwed tight. The more carefully and precisely you do this, the better will be the joint as a whole.

Mitre and frame joint

Making a mitre joint



Joining mitring perfectly is an art all by itself, but with the Undercover Jig, even this works first time. It is only necessary to fasten the workpieces on the workbench with a clamp in order to obtain exact and seamless mitre joints.



Clamp one of the mitres together with the drill guide on the workbench. For reasons of stability, and so that the mitring does not become distorted, there should always be two holes per mitring. For particularly narrow frames, drill only one hole and reinforce the mitring with glue.

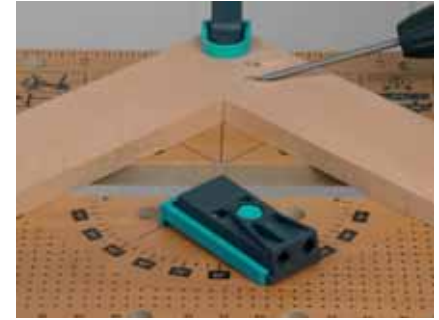

Even for a mitre joint, it is essential how precisely the two wood pieces are fixed to each other. The board must not under any circumstances be allowed to slip during the screwing process. The reward is a perfect and almost invisible joint, which is also more durable than any dowel joint.

Making a frame



Picture frames and radiator panelling, where only the outside of the frame is visible, are perfect examples of the application of the Undercover Jig. After two holes have been drilled in the two diagonal frame pieces at the face ends, the whole frame can be fixed with clamps and permanently and very durably jointed with two chipboard screws each.



Regardless of the form of the frame or the frame corner, using the Undercover Jig you can joint almost everything simply and rapidly with two ordinary chipboard screws, without any expense for machines or accessories. Since no special screws are necessary, you can obtain supplies of the appropriate jointing screws in any DIY market.

Joining shelf bottoms



In future, you will be able to screw shelf bottoms from inside or from below and will no longer have to screw through the side wall as you used to have to.

Important safety tip: children who like to climb love to use shelves as a ladder, so shelves should not simply be laid on shelf supports, but screwed firmly to the side walls – a clear case for the Undercover Jig!

Repairs with the Undercover Jig

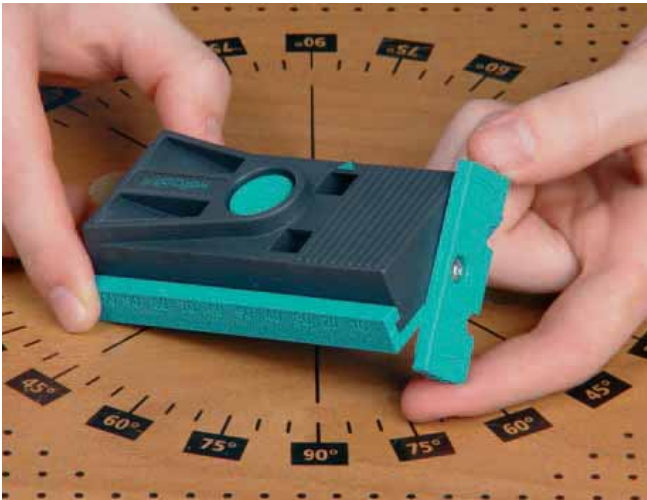

All repair work is done without the front stop, since it is no longer possible to take apart the wood pieces that are to be joined and work them separately. In addition, the stop can be swivelled out of the way by turning it, so that there is no longer a stop edge under the Undercover Jig.



Drawers that are coming apart at the corners also do not have to be completely taken apart in order to repair them. It is sufficient to fix the Undercover Jig with the stop swivelled out of the way in the defective corner and drill two holes. Then the appropriate screws are inserted and the two wood pieces are again firmly screwed together to form a corner.

Repairing a defective cabinet corner



If the stop is swivelled out of the way, defective cabinet corners can be firmly joined together again without first having to take the cabinet apart. For this purpose, the Undercover Jig is simply clamped under the bottom. However, for these repair works, the screws must be 5 mm longer.



Next, simply insert the chipboard screw of the right length into the hole drilled and screw it tight with the extended bit head supplied. This automatically fixes the side wall to the bottom and the bottom and side wall once again form a perfect cabinet corner.

The conical plates



Behind the product name “conical plate” hides a small and unassuming helper that has a big effect. When you want to fill up knotholes or cover up unsightly screw holes, these thin circular plates of pinewood provide a rapid, uncomplicated solution. In addition to this, the conical plates, which can be obtained in the diameters 15, 20, 25, 30, 35 and 40 mm are also very good for numerous other applications. For example, they can provide excellent service as wheels when constructing children’s toys.

Application and fields of use of conical plates



Area of application:

Conical plates can be drilled in very precisely on a drilling rig with a Forstner bit matching the diameter of the plate. The drilling rig not only provides an absolutely vertical drill hole, it also allows the depth of the drill hole to be precisely regulated. If the workpiece is too large for the drilling rig, the “tec-mobil” from **wolcraft**®, as a mobile drilling rig, offers the same advantages as a stationary drilling rig.



Filling in knotholes

Particularly in pine and spruce wood, depending on the quality, there may be many small knotholes in the wood. Knotholes which have become loose and no longer sit firmly in the wood should be drilled out and replaced with a conical plate which is slightly larger than the knothole. Put a little wood glue into the drill hole and then knock the conical plate in with a hammer. After the glue has dried, grind the plate flush.















Cover screw heads



If you want to cover screw heads with conical plates, you first need to drill a blind hole of the same diameter as the platelet before you tighten the screw. After the screw has been tightened, you can then knock in the conical plate with a little glue, and after it has dried, grind it flush with the surface of the wood with an orbit sander or a half-sheet finish sander.

All products at a glance!

Dowel Joints

	4642 000*	1	Set of Undercover Jig	Undercover Jig, stepped drill, depth stop, screw hole covers, wood screws
	2933 000	1	Stepped drill + Tiefenstopp	for Undercover Jig
	2928 000*	12	Screw-hole covers	for Undercover Jig
	2939 000*	30	Dowel pins	Beech wood, Ø 9,5 x 40 mm, for Undercover Jig
	3750 000*	1	Universal doweling set	with wood dowels, wood drills Ø 8 mm + depth stop, Ø 6, 8, 10 mm
	4640 000	1	Dowelmaster	Ø 6, 8, 10 mm
	4645 000*	1	Universal wood doweling set	dowelmaster, wood drills, wood dowels, centre points, depth stops, wood glue
	4650 000	1	Dowelling Jig	Ø 5, 6, 8, 10 mm
	2905 000*	200	Dowel pins	Beech wood, Ø 6 x 30 mm
	2906 000*	50	Dowel pins	Beech wood, Ø 6 x 30 mm
	2907 000*	150	Dowel pins	Beech wood, Ø 8 x 40 mm
	2908 000*	40	Dowel pins	Beech wood, Ø 8 x 40 mm
	2909 000*	120	Dowel pins	Beech wood, Ø 10 x 40 mm
	2910 000*	30	Dowel pins	Beech wood, Ø 10 x 40 mm
	2730 000	3	Dowel drills	with centre point + depth stops Ø 6, 8, 10 mm
	2731 000	1	Dowel drills	with centre point + depth stop Ø 6 mm
	2732 000	1	Dowel drills	with centre point + depth stop Ø 8 mm
	2733 000	1	Dowel drills	with centre point + depth stop Ø 10 mm
	2751 000	3	Depth stops	Ø 6, 8, 10 mm
	2911 000	4	Centre points	Ø 6 mm
	2912 000	4	Centre points	Ø 8 mm
	2913 000	4	Centre points	Ø 10 mm
	2916 000*	1	Dowel kit Ø 6 mm	with centre point, wood drill, depth stop, dowels Ø 6 x 30 mm
	2917 000*	1	Dowel kit Ø 8 mm	with centre point, wood drill, depth stop, dowels Ø 8 x 40 mm
	2918 000*	1	Dowel kit Ø 10 mm	with centre point, wood drill, depth stop, dowels Ø 10 x 40 mm

Biscuit Joints

	2920 000	1	Multi wood jointer (CE)	or one-hand angle grinders with M 14 thread
	2921 000*	50	Jointing biscuits	No. 0
	2922 000*	50	Jointing biscuits	No. 10
	2923 000*	50	Jointing biscuits	No. 20
	2949 000*	150	Jointing biscuits	No. 10
	2924 000	1	TCT cutter	for art. no. 2920 000, Ø 100 mm

Wooden Parts

	2940 000	50	Konus biscuits	Ø 15 mm
	2941 000	40	Konus biscuits	Ø 20 mm
	2942 000	20	Konus biscuits	Ø 25 mm
	2943 000	10	Konus biscuits	Ø 30 mm
	2944 000	10	Konus biscuits	Ø 35 mm
	2945 000	8	Konus biscuits	Ø 40 mm



The mark of responsible forestry

* Our wood products are certified according to Forest Stewardship Council (FSC) regulations and meet all minimum requirements. Please visit www.fsc.org to find all information about the FSC seal.

Notes



© **wolfcraft® GmbH**

Wolff-Straße 1
D-56746 Kempenich

Service Hotline: 00 49 (0) 26 55 51 280

Fax: 00 49 (0) 26 55 51 180

E-Mail: customerservice@wolfcraft.com

Technischer Support

Fax: 00 49 (0) 26 55 50 20 80

E-Mail: technical.Service@wod.wolfcraft.com

